

Entity-relationship diagrams of the FR family of models

Functional Requirements for Bibliographic
Records (FRBR), Functional Requirements for
Authority Data (FRAD), Functional
Requirements for Subject Authority Data
(FRSAD)

These diagrams are taken from the published versions of the FR models

FRBR Group 1 entities and primary relationships

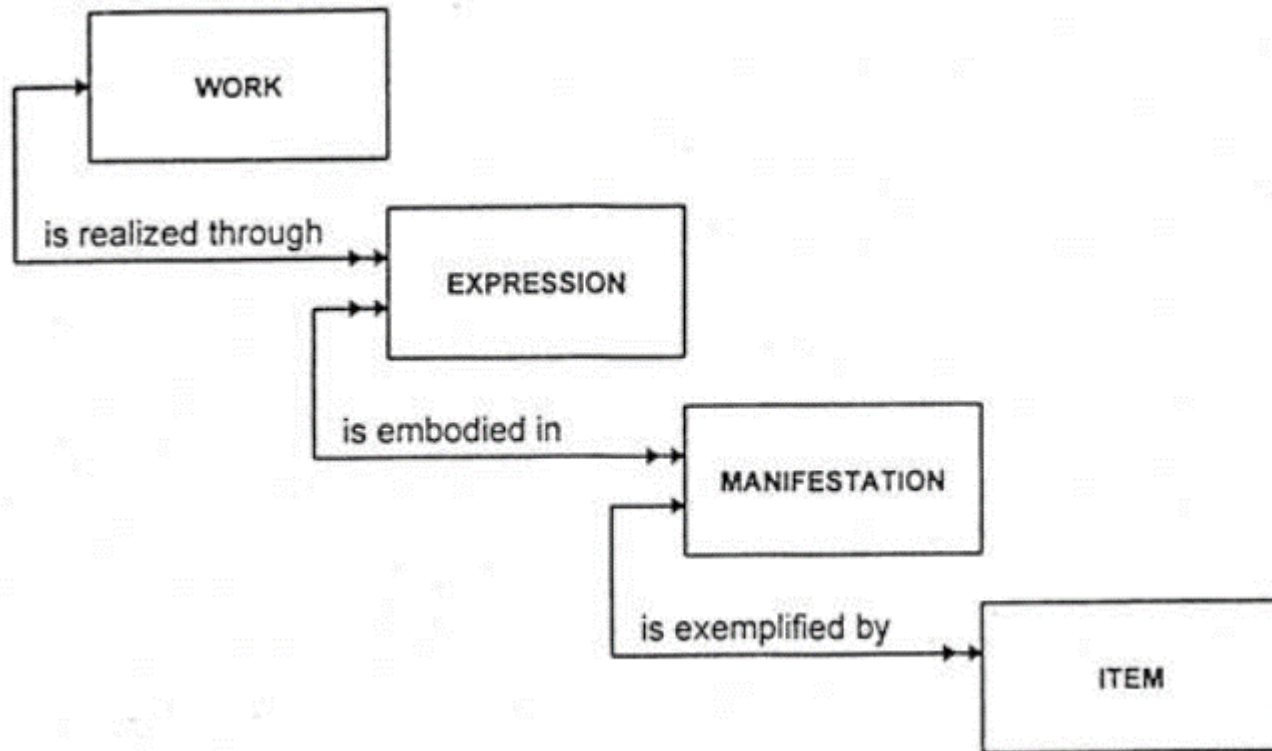

FRBR Group 2 entities and “responsibility” relationships

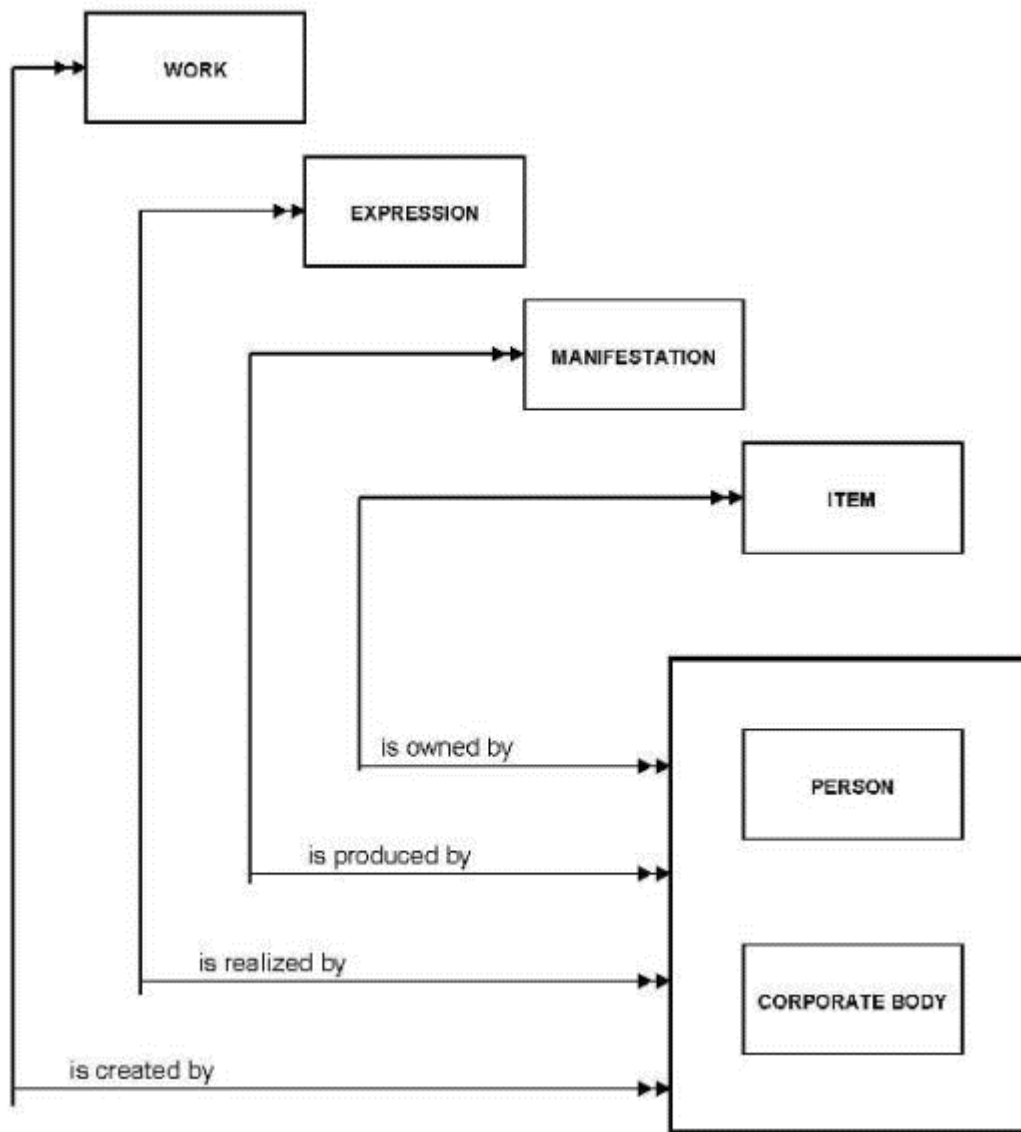

FRBR Group 3 entities and “subject” relationships

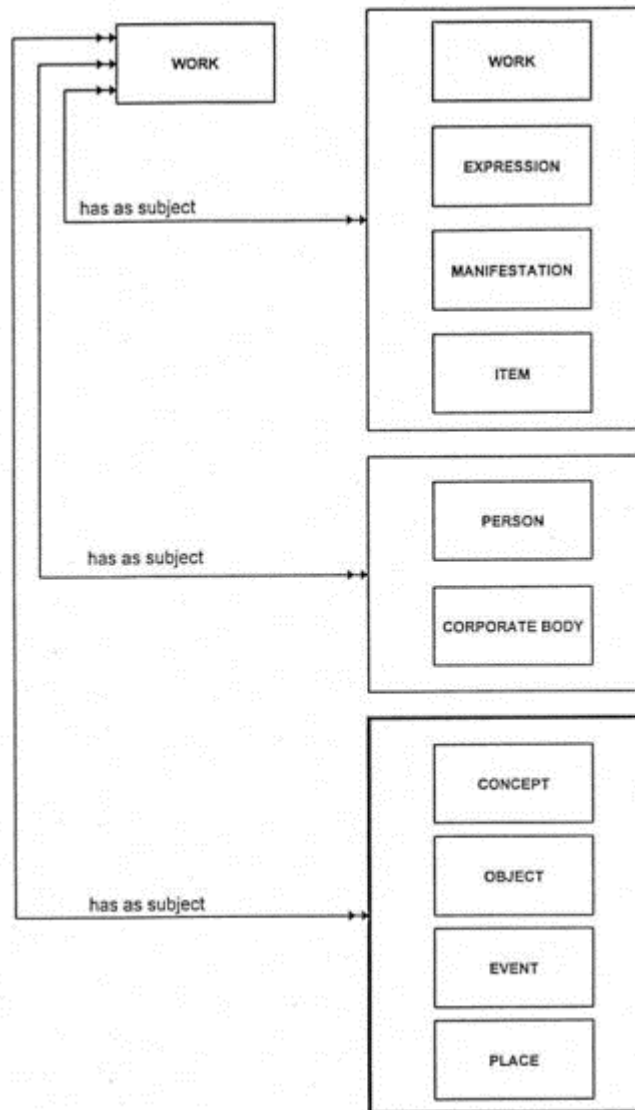

Fundamental basis for the FRAD model

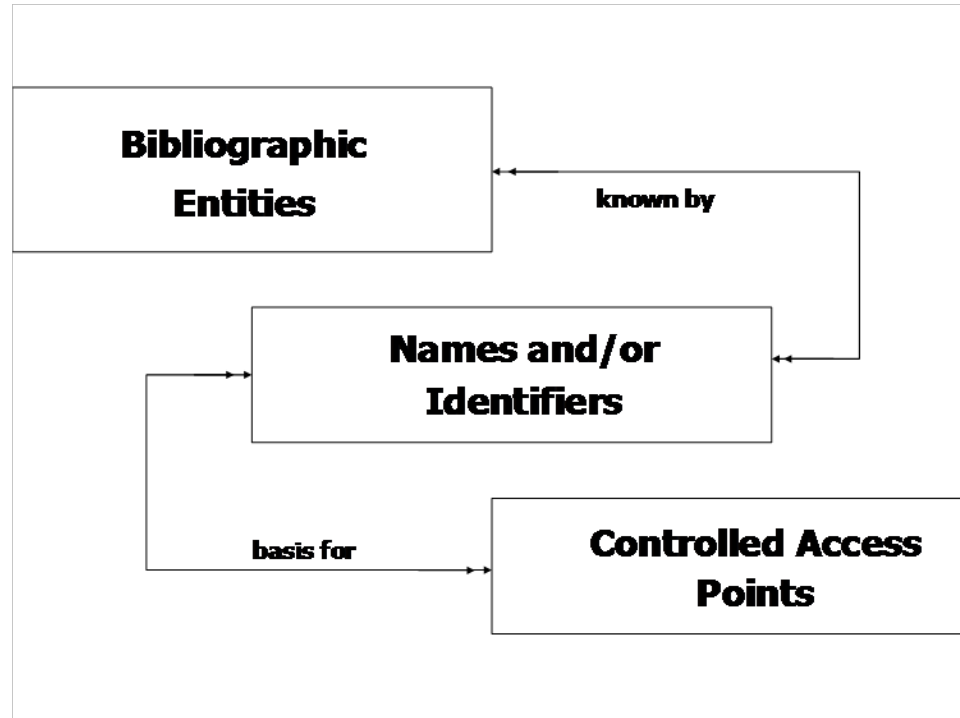

FRAD conceptual model for authority data (top)

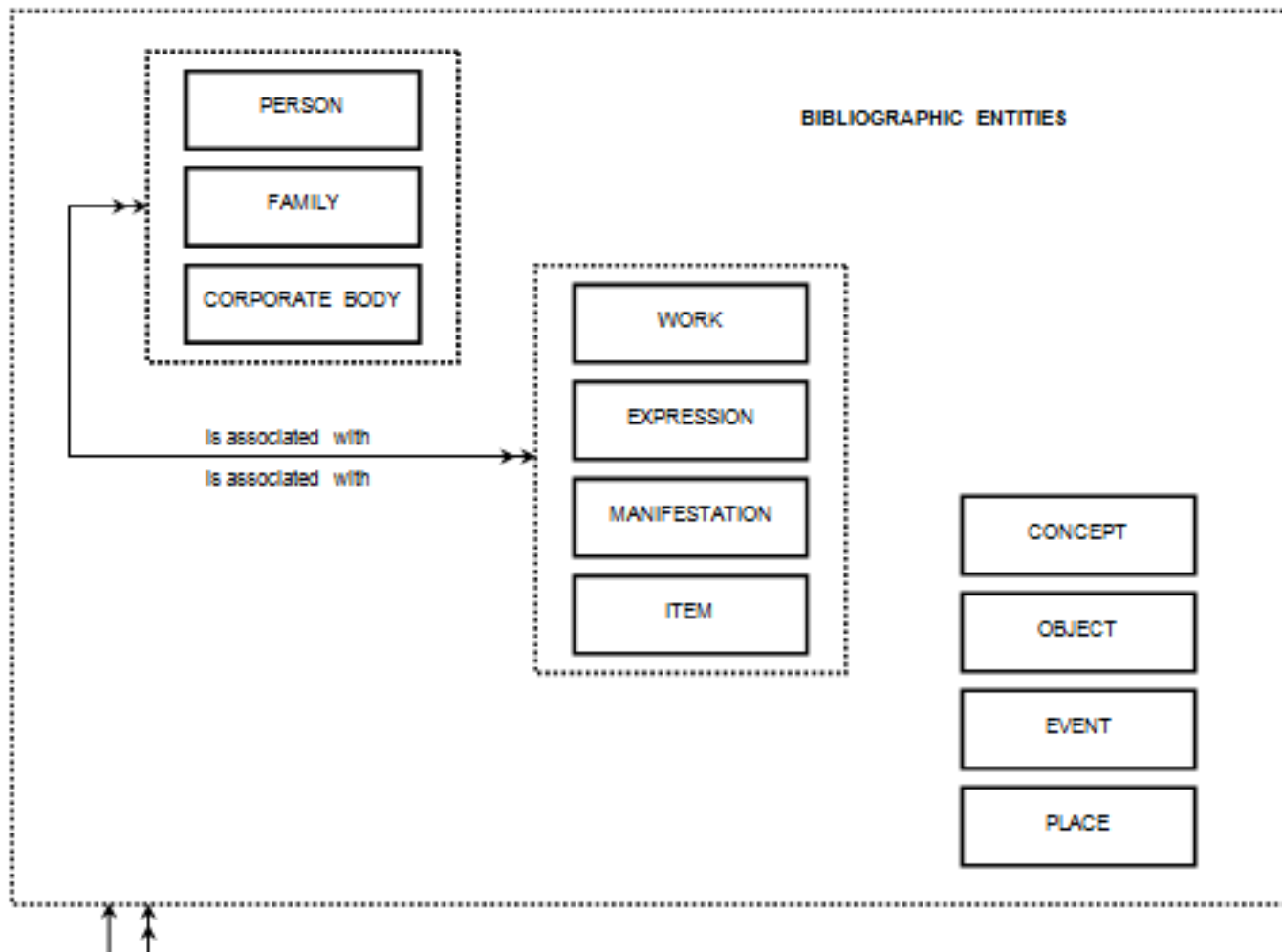

FRAD conceptual model for authority data (bottom)

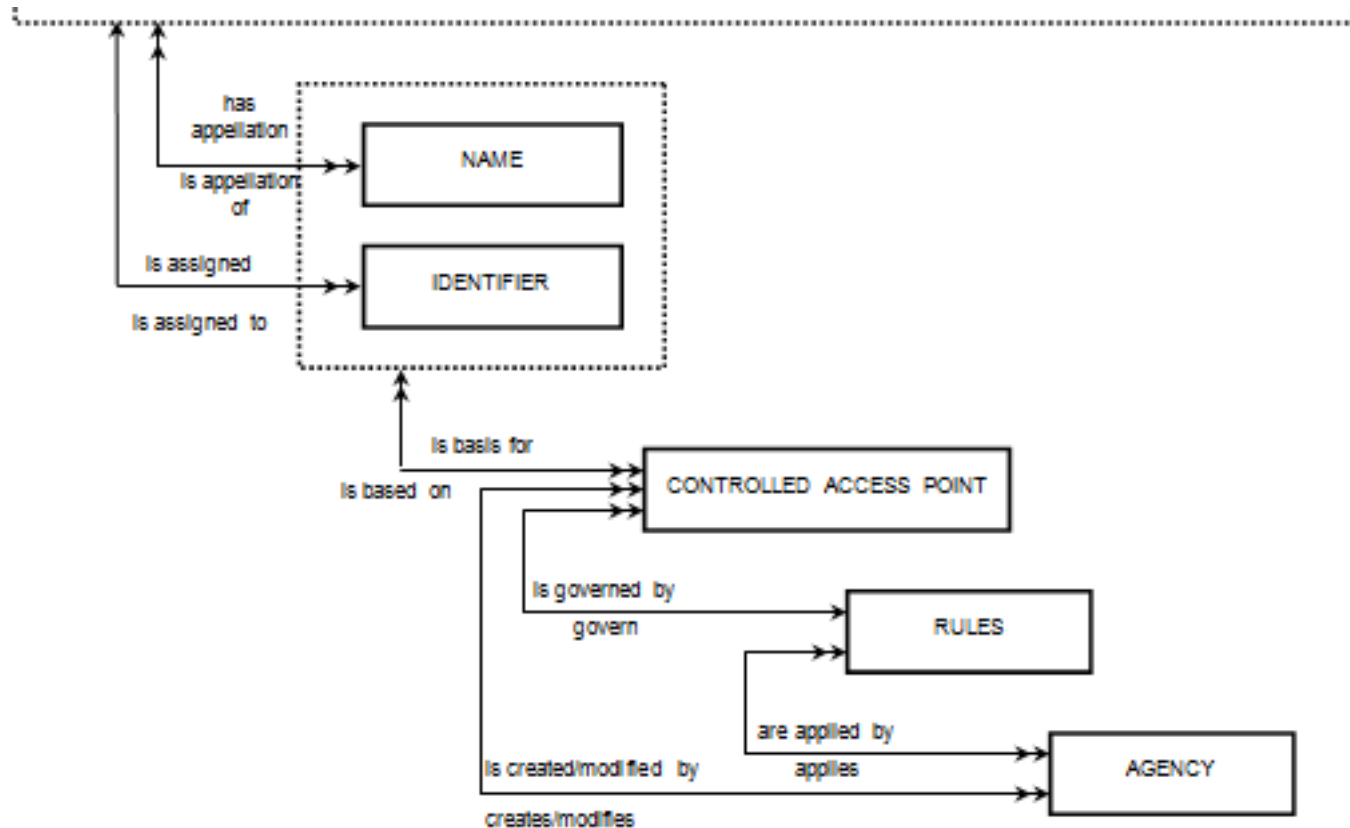

FRSAD's relation to FRBR (FRAD entity Family added)

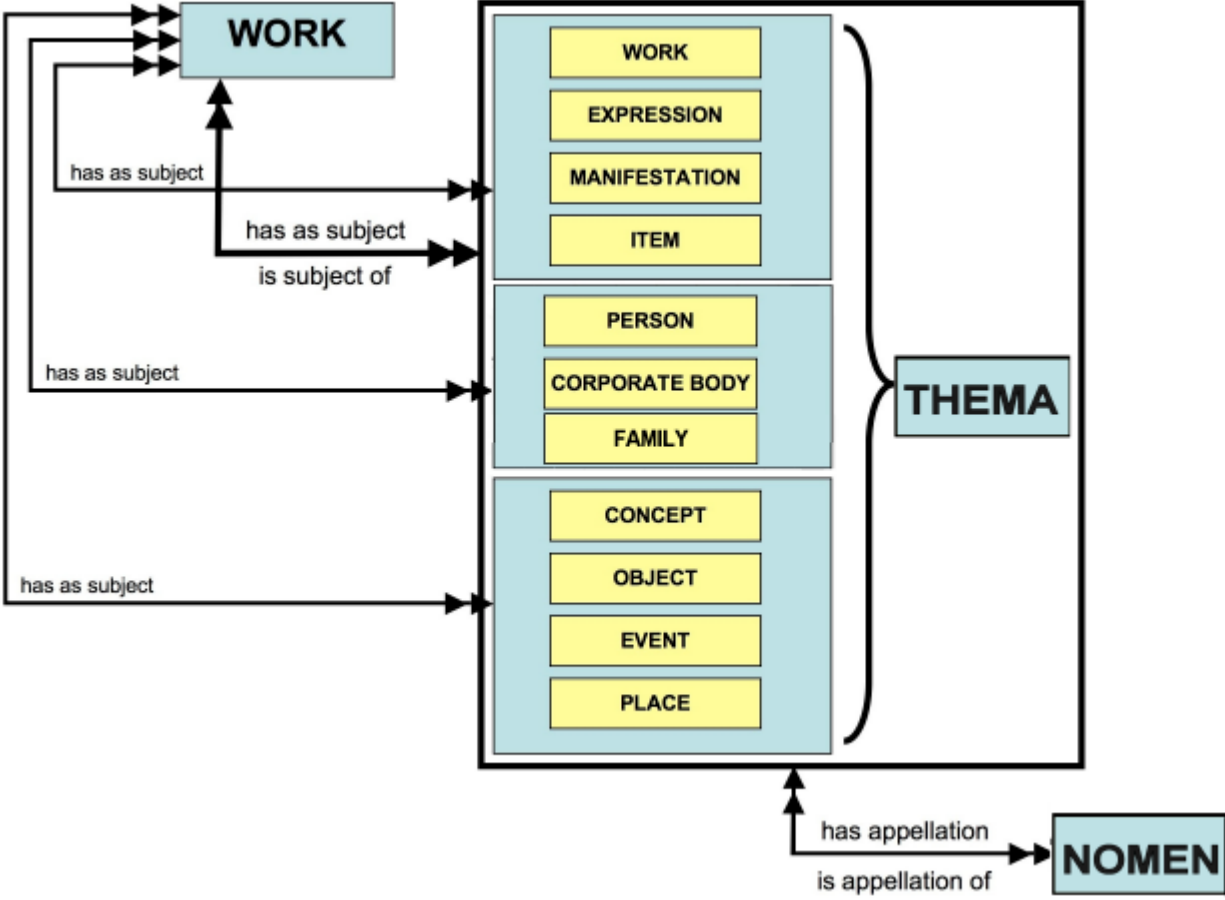

FRSAD conceptual model

